



Victorian Certificate of Education 2003

SUPERVISOR TO ATTACH PROCESSING LABEL HERE

STUDENT NUMBER

Letter

Figures	<input type="text"/>	<input type="text"/>	<input type="text"/>	<input type="text"/>	<input type="text"/>	<input type="text"/>	<input type="text"/>	<input type="text"/>	<input type="text"/>	<input type="text"/>
Words	<input type="text"/>	<input type="text"/>	<input type="text"/>	<input type="text"/>	<input type="text"/>	<input type="text"/>	<input type="text"/>	<input type="text"/>	<input type="text"/>	<input type="text"/>

BIOLOGY

Written examination 2

Monday 3 November 2003

Reading time: 3.00 pm to 3.15 pm (15 minutes)

Writing time: 3.15 pm to 4.45 pm (1 hour 30 minutes)

QUESTION AND ANSWER BOOK

Structure of book

Section	Number of questions	Number of questions to be answered	Number of marks	Suggested times (minutes)
A	25	25	25	30
B	8	8	50	60
			Total 75	90

- Students are permitted to bring into the examination room: pens, pencils, highlighters, erasers, sharpeners and rulers.
- Students are NOT permitted to bring into the examination room: blank sheets of paper and/or white out liquid/tape.
- No calculator is allowed in this examination.

Materials supplied

- Question and answer book of 22 pages.
- Answer sheet for multiple-choice questions.

Instructions

- Write your **student number** in the space provided above on this page.
- Check that your **name** and **student number** as printed on your answer sheet for multiple-choice questions are correct, **and** sign your name in the space provided to verify this.
- All written responses must be in English.

At the end of the examination

- Place the answer sheet for multiple-choice questions inside the front cover of this book.

Students are NOT permitted to bring mobile phones and/or any other electronic communication devices into the examination room.

SECTION A – Multiple-choice questions**Instructions for Section A**

Answer **all** questions in pencil on the answer sheet provided for multiple-choice questions.

Choose the response that is **correct** for the question.

A correct answer scores 1, an incorrect answer scores 0.

Marks will **not** be deducted for incorrect answers.

No marks will be given if more than one answer is completed for any question.

Use the following information to answer Question 1.

The photograph in Figure 1 was prepared from a sample of cells from a fetus, collected during amniocentesis.

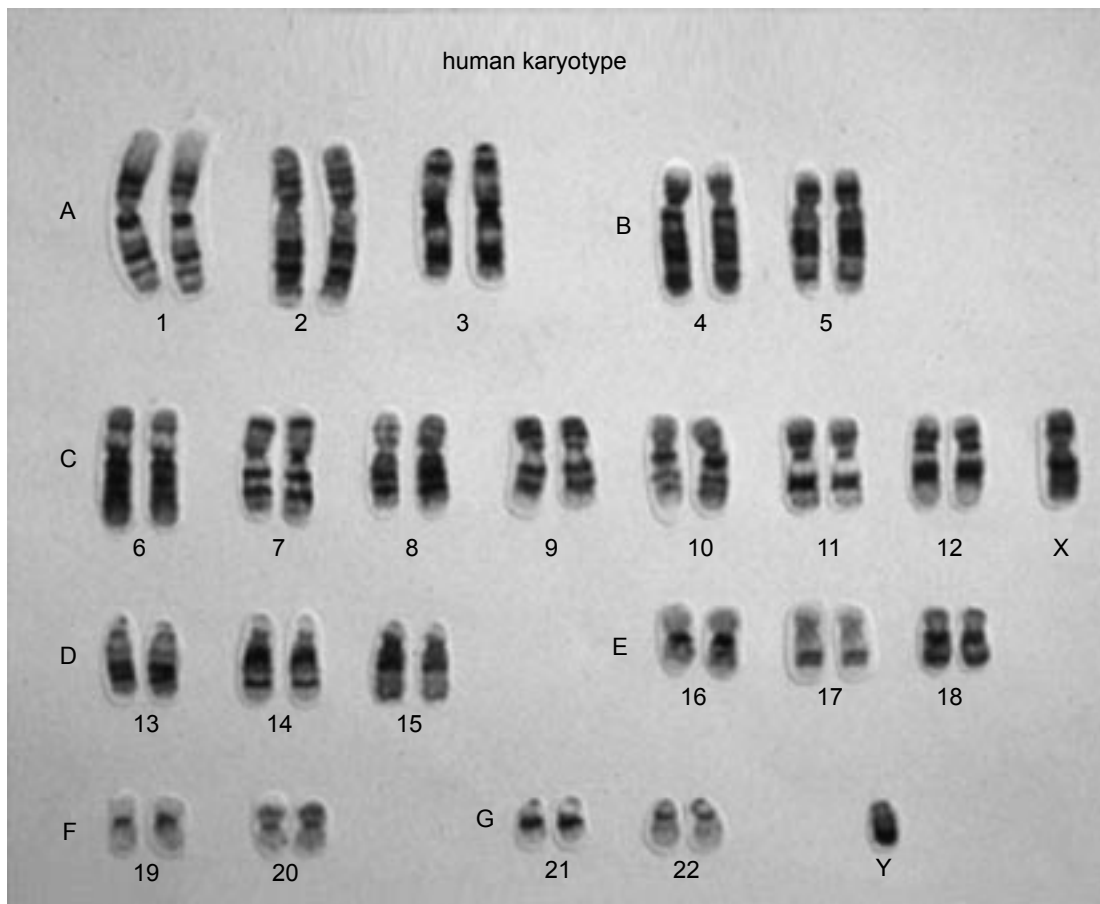

Figure 1

Question 1

From the photograph it is reasonable to conclude that

- A. the fetus is a female.
- B. there are 44 autosomes.
- C. the DNA sequence is identical along each of the pair of chromosomes labelled 13.
- D. the centromeres of the chromosomes in Group A are near the ends of the chromosomes.

Use the following information to answer Question 2.

The hair colour of Australian shepherd dogs is under genetic control. The colour of the hair found inside the ears, on the legs and under the tails, is under the control of a gene that has the following alleles.

- A^W white
- a^S sable colour
- a^c copper colour

White is dominant to both sable and copper colour. Sable colour is dominant to copper colour.

Question 2

If two dogs with the genotypes $A^W a^c$ and $a^S a^c$ are mated, the resulting offspring could have

- A. 4 genotypes and 4 phenotypes.
- B. 4 genotypes and 3 phenotypes.
- C. 3 genotypes and 4 phenotypes.
- D. 3 genotypes and 3 phenotypes.

Question 3

Several male mice with bent tails were mated to female mice with straight tails. All of the F_1 males had straight tails and all of the F_1 females had bent tails.

It is reasonable to conclude that

- A. the gene involved in this cross is autosomal.
- B. the female parent with a straight tail is heterozygous.
- C. this cross demonstrates that bent tails is the recessive phenotype.
- D. the F_1 female is heterozygous.

Question 4

With respect to the ABO blood group locus it is possible to produce children of four different phenotypes if the parents are

- A. type B x type B.
- B. type A x type B.
- C. type O x type AB.
- D. type AB x type AB.

Use the following information to answer Questions 5–7.

The pedigree in Figure 2 shows the inheritance of Tay Sachs disease, a progressive neurological defect in humans.

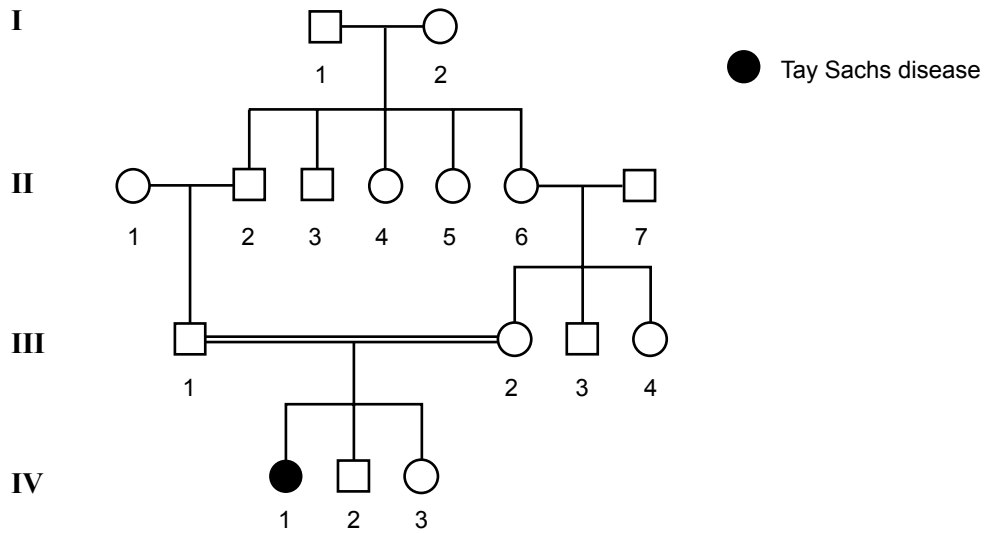

Figure 2

Question 5

It is reasonable to conclude from the pedigree that the trait shown is

- A. X-linked recessive.
- B. X-linked dominant.
- C. autosomal recessive.
- D. autosomal dominant.

Question 6

The chance that a fourth child of III–1 and III–2 is male, and affected with Tay Sachs disease, is

- A. $\frac{1}{8}$
- B. $\frac{1}{4}$
- C. $\frac{1}{2}$
- D. $\frac{3}{4}$

Question 7

The chance that IV–2 is heterozygous for Tay Sachs disease is

- A. $\frac{1}{4}$
- B. $\frac{1}{2}$
- C. $\frac{2}{3}$
- D. $\frac{3}{4}$

Question 8

In DNA, the number of

- A. phosphate groups equals the number of nitrogen bases.
- B. adenine nucleotides equals the number of cytosine nucleotides.
- C. phosphate groups equals twice the number of sugar molecules.
- D. guanine nucleotides equals the number of uracil nucleotides.

Question 9

During DNA replication

- A. messenger RNA (mRNA) is produced.
- B. reverse transcriptase enzymes play an important role.
- C. bonds between phosphate and sugar molecules break.
- D. each of the DNA strands acts as a template strand.

Use the following information to answer Question 10.

Figure 3 shows portion of a cell engaged in protein synthesis. The various parts of the cell are not drawn to scale.

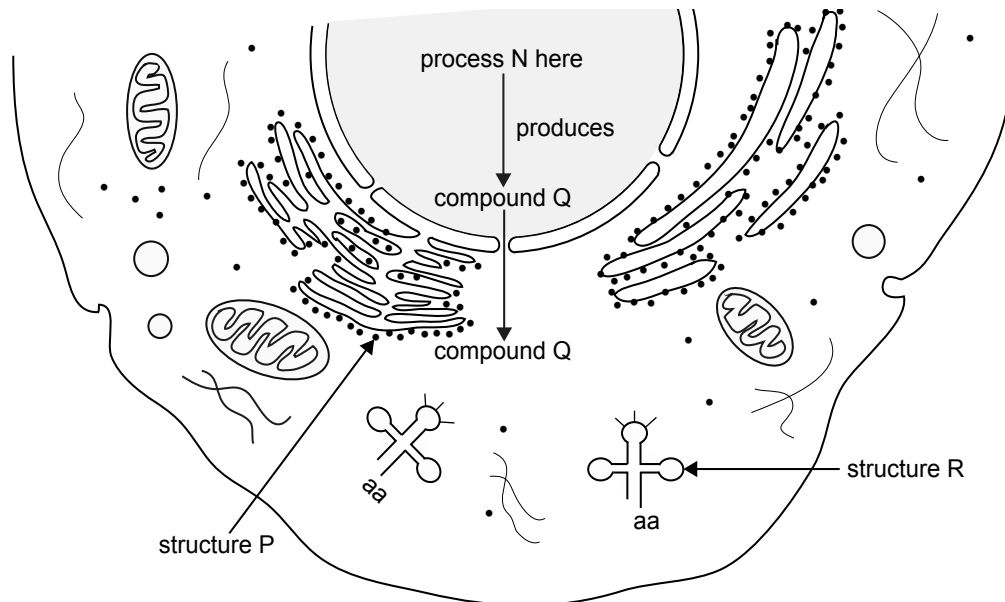

Figure 3

Question 10

It is reasonable to conclude that

- A. process N is translation.
- B. structure P is made of t-RNA.
- C. compound Q is messenger RNA.
- D. structure R is the site of protein synthesis.

Use the following information to answer Questions 11 and 12.

Three gene loci in mice are shown below.

locus 1	locus 2	locus 3
agouti coat colour (A) albino coat colour (a)	kinky tail (K) straight tail (k)	non-frizzy coat (F) frizzy coat (f)

Crosses involving two loci at a time were set up and their outcomes are shown in the table.

Parents (purebreeding)	F ₁	Offspring of a testcross of the F ₁
cross 1 agouti, non-frizzy coat x albino, frizzy coat	agouti, non-frizzy coat	agouti, non-frizzy 44
		albino, frizzy 46
		agouti, frizzy 5
		albino, non-frizzy 5
cross 2 agouti, straight tail x albino, kinky tail	agouti, kinky tail	agouti, straight 23
		albino, kinky 27
		agouti, kinky 24
		albino, straight 26

Question 11

From the outcome of the testcross of the offspring of **cross 1** it can be concluded that

- A. the genotype of the F₁ of cross 1 is $\frac{Af}{aF}$.
- B. the frizzy locus and the albino locus are assorting independently.
- C. the map distance between the albino and frizzy loci is 10 map units.
- D. the agouti, non-frizzy offspring of the testcross, are called recombinant offspring.

Question 12

From the **cross 2** data it can be concluded that

- A. straight tail is the dominant phenotype.
- B. the albino coat, straight-tailed offspring are heterozygous.
- C. the agouti coat and kinky-tailed offspring of the testcross of the F₁ are heterozygous at both loci.
- D. when the F₁ mice were testcrossed, they were crossed to mice with agouti-coloured coats and straight tails.

Use the following information to answer Questions 13 and 14.

Haemoglobin consists of four polypeptide chains. In normal haemoglobin, two of these chains are beta chains, each comprising 146 amino acids. Variations exist in the amino acid composition of these chains and this results in different kinds of haemoglobins. One of these variants is called haemoglobin S.

The first seven amino acids in the beta chains of these two haemoglobins, and the amino acid at position 143 are given below. The amino acids at each of the remaining positions are the same for each haemoglobin.

Position of amino acid in haemoglobin chain	1	—	2	—	3	—	4	—	5	—	6	—	7...	...143...
normal adult haemoglobin	val	—	his	—	leu	—	thr	—	pro	—	glu	—	glu...	...his...
haemoglobin S	val	—	his	—	leu	—	thr	—	pro	—	val	—	glu...	...his...

The genetic code for the amino acids in these sequences, coded for by the template strand of DNA, is shown in the following table.

DNA triplet	Amino acid	DNA triplet	Amino acid
CAA or CAG or CAT or CAC	val	TGA or TGG or TGT or TGC	thr
GTA or GTG	his	GGA or GGG or GGT or GGC	pro
AAT or AAC or GAA or GAG or GAT or GAC	leu	CTT or CTC	glu

Question 13

It is reasonable to conclude that during transcription of normal haemoglobin, the mRNA codon sequence could be

- A. GTT for amino acid 1.
- B. ACT for amino acid 4.
- C. CTT for amino acid 3.
- D. CAC for amino acid 2.

Question 14

Considering the DNA responsible for the haemoglobins, it is reasonable to conclude that

- A. haemoglobin S could be the result of a single base mutation in the DNA of adult haemoglobin.
- B. deletion of nucleotide 12 would change the fourth amino acid in the sequence of adult haemoglobin.
- C. a change in the 4th base of the DNA sequence would produce no change in either of the two haemoglobins.
- D. in haemoglobin S, a change in the 10th base of the DNA sequence would produce no change in the amino acid sequence.

Question 15

Evidence for evolution includes data from comparative anatomy and embryology. When comparing two species such evidence would be obtained from

- A. chromosome numbers.
- B. mitochondrial DNA.
- C. shared habitats.
- D. the presence of gill slits during development.

Question 16

Geographical isolation is important in assisting the process of

- A. adaptation.
- B. gene flow.
- C. speciation.
- D. fossilisation.

Question 17

Snakes and legless lizards evolved separately from ancestors with legs.

The lack of legs in these reptiles is an example of

- A. analogy.
- B. divergence.
- C. founder effect.
- D. polymorphism.

Question 18

The Eastern Barred Bandicoot (*Perameles gunnii*) is a species in serious danger of extinction on mainland Australia. The last remaining wild population is located near Hamilton in western Victoria. In the late 1980s a captive breeding program for the Eastern Barred Bandicoot was established.

This captive breeding program will help prevent the extinction of this species by

- A. reducing habitat destruction in the Hamilton region.
- B. reducing the genetic diversity in the bandicoot population.
- C. increasing bandicoot numbers for reintroduction to their natural habitat.
- D. increasing feral predator numbers so the bandicoots can get used to them.

Question 19

The linking of the present-day distributions of organisms with past movements of continental plates is referred to as

- A. continuous variation.
- B. biogeography.
- C. genetic drift.
- D. biodiversity.

Question 20

For a species living in an unchanging environment

- A. there are no selection pressures.
- B. the selection pressures remain constant.
- C. the only selection pressure is genetic drift.
- D. all individuals are equally suited to the selection pressures.

Use the following information to answer Question 21.

Figure 4 shows the results of a breeding experiment with the vinegar fly *Drosophila melanogaster*. In each of the first 25 generations the smallest flies were selected to produce the next generation. After 25 generations the selection was reversed. From generation 25–35 the largest flies were chosen to breed the next generation.

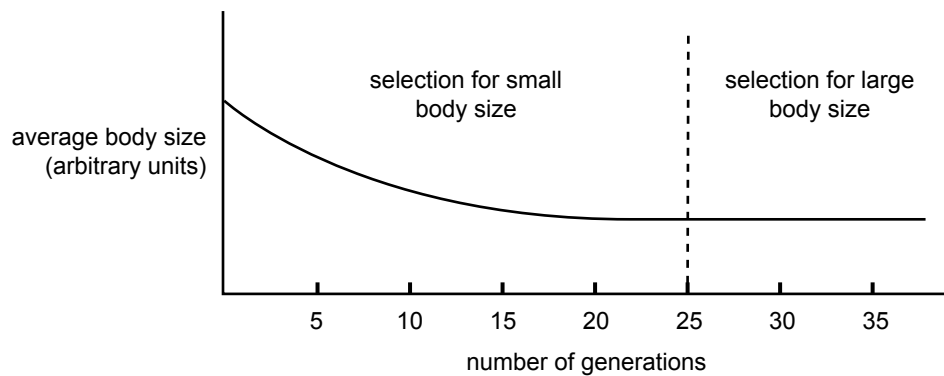

Figure 4

Question 21

With respect to the genes controlling body size, the results of the experiment suggest that

- A. after 25 generations there was no genetic variation.
- B. for the first 25 generations there was no genetic variation.
- C. selection between generations 25 and 35 had a significant effect on average body size.
- D. if selection for small body size continued after generation 25, average body size would continue to fall.

Question 22

In a group of organisms, individuals genetically identical at a particular single gene locus show a variety of phenotypes for the trait. It is reasonable to conclude that the variation in phenotypes for this trait is the result of

- A. codominance.
- B. polygenic inheritance.
- C. environmental influences.
- D. multiple alleles at the locus.

Use the following information to answer Question 23.

A single gene locus with two alleles determines the colour of snapdragon flowers. A flower may have one of 3 phenotypes.

phenotype	genotype
red	$C^R C^R$
pink	$C^R C^W$
white	$C^W C^W$

A student investigated the frequency of each of these phenotypes in a population of 100 snapdragon plants. The frequency of each phenotype and genotype is shown in the table.

red ($C^R C^R$)	pink ($C^R C^W$)	white ($C^W C^W$)
40	40	20

Question 23

From this data it can be concluded that

- A. the number of C^W alleles in this population is 20.
- B. the number of C^R alleles in this population is 120.
- C. the proportion of C^R alleles in this population is 0.4.
- D. the total allele pool for this locus in this population is 100.

Use the following information to answer Question 24.

In a species of marine snail the colour of the shell is controlled by a single gene with 2 alleles, **G** and **g**.

Allele frequencies for this locus were determined in six populations of snails. These populations were located close to each other, but not able to interbreed. The frequencies of the **G** allele are shown in the table below.

	Population					
	1	2	3	4	5	6
Frequency of G allele	0.7	0.9	0.0	1.0	0.7	0.4

Question 24

The frequency of the **g** allele in population 5 is

- A. 0.15
- B. 0.3
- C. 0.35
- D. 0.7

Question 25

The variation in allele frequencies between several isolated populations can be due to genetic drift.

Genetic drift is likely to be observed when

- A. there is gene flow.
- B. the mutation rate is high.
- C. there are strong selective pressures.
- D. a population is reduced to a few individuals.

SECTION B – Short-answer questions**Instructions for Section B**

Answer this section in pen.

Answer **all** questions in the spaces provided.

Question 1

The back of the leopard frog (*Rana pipiens*) can be either patterned or non-patterned.

Several patterned frogs were allowed to breed and they produced 75 patterned offspring and 25 non-patterned offspring.

- a. i. Which of the phenotypes, patterned or non-patterned, is dominant?

- ii. Explain your answer to i.

1 + 1 = 2 marks

- b. Using your own allelic notation, show the genotypes with their respective phenotypes for the parents and offspring of the cross between the patterned frogs described above.

3 marks

Crosses between patterned and non-patterned frogs were performed. Not all crosses produced the same outcome. The results are shown in the table below. For both cross A and cross B there were large numbers of offspring produced.

	Parents		Offspring
cross A	patterned	non-patterned	all patterned
cross B	patterned	non-patterned	$\frac{1}{2}$ patterned; $\frac{1}{2}$ non-patterned

- c. The parents in crosses A and B have the same phenotypes. Explain why the outcome of crosses A and B are different.

2 marks

Total 7 marks

Question 2

Purebreeding guinea pigs with rough textured black coats were crossed to purebreeding guinea pigs with smooth textured white coats. The F₁ were all rough textured with black coats. The F₁ were allowed to interbreed to produce an F₂. The numbers of each phenotype produced in the F₂ are shown in the table.

F ₂ offspring	number
rough, black	95
rough, white	32
smooth, black	27
smooth, white	11
Total	165

- a. There are two genes involved in these crosses. What information provided in the results confirms that there are two genes each with two alleles?

2 marks

b. Use allelic symbols **R** and **r** for the texture locus, and **B** and **b** for the colour locus.

i. What are the genotypes of the purebreeding parental guinea pigs?

Indicate in your answer which genotype matches which phenotype.

ii. What is the genotype of the F₁ guinea pigs? _____

iii. Give one genotype for an F₂ smooth, black guinea pig. _____

2 + 1 + 1 = 4 marks

c. The two pairs of chromosomes, on which these two gene loci are located, assort independently. What does 'assort independently' mean? Include a diagram in your answer.

3 marks

Total 9 marks

Question 3

In specialised cells in the ovary and testis, cells divide by the process of meiosis to produce gametes. A cell with a diploid number of 4 underwent meiosis. The following images illustrate different stages throughout the total process of meiosis in this cell.

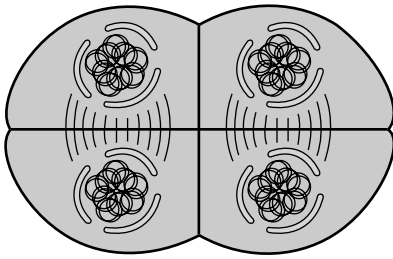

A

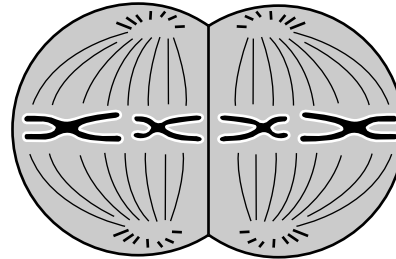

B

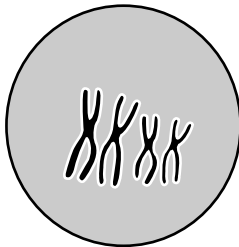

C

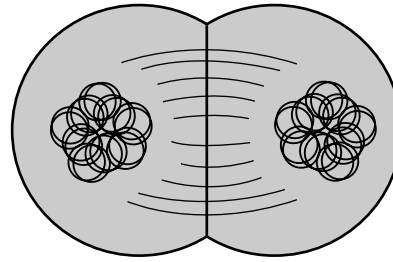

D

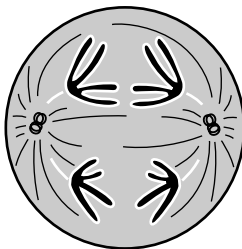

E

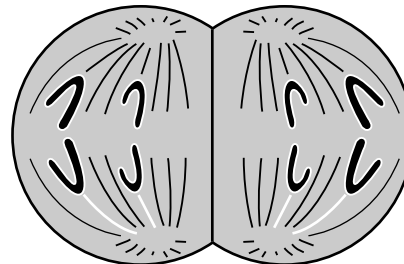

F

- a. Using the letters under each cell (A–F), put the cells in order commencing with the earliest stage of meiosis shown.

2 marks

- b. During meiosis, crossing over and recombination occur between homologous chromosomes. Describe the outcome of recombination.

2 marks

- c. During meiosis the nucleus undergoes two divisions.

- i. Which of the cells, **E** or **F**, represents anaphase 1? _____

- ii. Explain how you reached your answer.

1 + 1 = 2 marks

Total 6 marks

Question 4

Genes can be transferred from one species to another in different ways. One method is to use plasmids, circular pieces of DNA found in some bacteria.

In this method, a plasmid is cut and a piece of foreign DNA inserted. The foreign piece of DNA usually contains more than one gene. The process is shown in Figure 5 below.

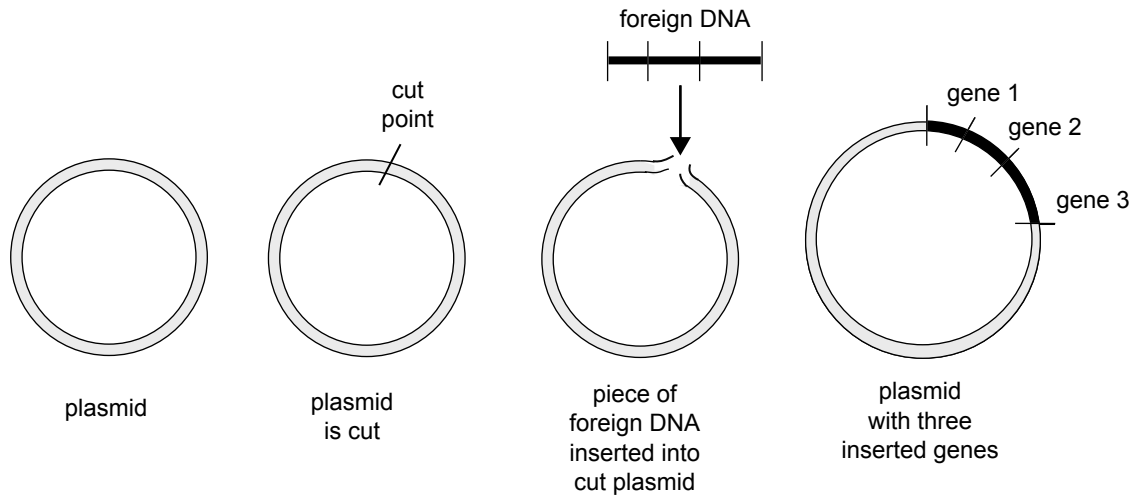

Figure 5

Many copies of the new plasmid are then incubated with bacteria.

- a. What is the name given to a plasmid that is used to transfer DNA from one organism to another?

1 mark

- b. What is used to cut the DNA of a plasmid? _____

1 mark

- c. What is used to join the inserted piece of DNA to the plasmid? _____

1 mark

One of the foreign genes inserted into the plasmid, codes for resistance to a particular antibiotic.

- d. Explain why it is important to include a gene for antibiotic resistance in the plasmid produced.

1 mark

Bacteria containing plasmids, that are constructed in the way outlined in Figure 5, can be used in a variety of settings with plants and animals.

For example, some plants are resistant to attack by insects. The plants produce a protein that poisons the larval stage of some insects that feed on them. The production of the protein is under genetic control.

A particular species of crop plant was genetically engineered to contain this gene. Such plants are referred to as GM (genetically modified) plants.

- e. Explain why a farmer might choose to grow a crop that was genetically engineered to be resistant to insects, rather than spray the crop with insecticide.

1 mark

Some plants are resistant to particular herbicides, chemicals that are used to kill plants. This trait is also under genetic control.

The gene that confers herbicide resistance has also been incorporated into some GM crop plants. This enables a farmer to spray his GM crop with a herbicide that will not harm the GM crop but does kill weed plants growing within the crop.

- f. Suggest one advantage for a farmer to be able to spray his crops with a herbicide.

1 mark

Two farmers have properties next door to each other. They grow the same cereal crop.

- Farmer X wishes to grow **GM** crops that are resistant to herbicide.
- Farmer Y wishes to continue to grow **non-GM** crops.

Farmer Y was concerned, and suggested to farmer X that pollen from the GM crop could fertilise the non-GM plants.

- g. Explain why farmer Y might be concerned about the possibility of his crop being fertilised by pollen from farmer X's crop.

1 mark

The farmers agreed to carry out field trials to establish whether leaving a gap between crops reduced the likelihood of cross-pollination. A number of trials were planted so that the results of one trial did not interfere in any way with the results of another. The percentage of seeds produced at various positions as a result of cross-pollination was measured for each trial. The outline of these trials and the results gathered are shown in the following table.

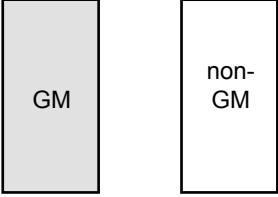
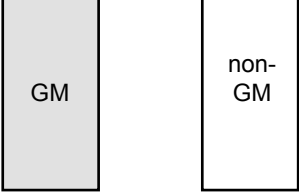
			Percentage of cross-pollination	
			at edge of non-GM crop	10 metres into non-GM crop
Trial 1		no gap between plots	10	2
Trial 2		5 metres between plots	1	0.5
Trial 3		7 metres between plots	1	0.3

h. From the data, what conclusions can be drawn about cross-pollination and the gap between crops?

3 marks

Total 10 marks

Question 5

Streptococcus pneumoniae is a bacterium which causes pneumonia in humans and may show resistance to antibiotics.

- a. How would antibiotic resistance have first occurred in the *Streptococcus pneumoniae* population?

1 mark

- b. The incidence of antibiotic resistant *Streptococcus pneumoniae* has increased in the last 15 years. Approximately 40% of infections by this bacterium are resistant to commonly used antibiotics.

- i. Explain how the increase in bacteria resistant to antibiotics has occurred.

- ii. What is the selective agent associated with the increase in antibiotic resistance in *Streptococcus pneumoniae*?

3 + 1 = 4 marks

Total 5 marks

Question 6

The table below shows the number of nucleotide differences between a region of mitochondrial DNA in humans, chimpanzees and a Neanderthal.

	Human 2	Chimpanzee 1	Chimpanzee 2	Neanderthal
Human 1	15	77	76	20
Human 2		79	80	27
Chimpanzee 1			23	72
Chimpanzee 2				71
Neanderthal				

- a. Based on the data in the table, which individual is most closely related to the Neanderthal?

1 mark

- b. The differences between the mitochondrial DNA recorded are the result of base substitutions. There are 77 nucleotide differences between Human 1 and Chimpanzee 1.

Explain why 77 nucleotide differences is a minimum number of base substitutions.

1 mark

- c. The Neanderthal DNA was extracted from a fossil approximately 25 000 years old.

- i. What other type of information obtained from the fossil could be used to assist in determining the evolutionary relationship of Neanderthals with humans and chimpanzees?

- ii. What method would be used to estimate the absolute age of the Neanderthal fossil?

- iii. What method could be used to determine the relative age of the Neanderthal fossil?

1 + 1 + 1 = 3 marks

Total 5 marks

Question 7.

Trilobites (Figure 6) are an extinct group of marine arthropods. They are a very well-studied group due to the abundance of fossils. Trilobites had a tough exoskeleton and bodies and legs divided into segments. They were distributed worldwide and occupied a range of habitats. They existed for almost 300 million years before becoming extinct around 250 million years ago.

**Figure 6**

- a. i. What structural feature improves the chances of a trilobite becoming a fossil?

- ii. Suggest one other reason why trilobite fossils are abundant.

1 + 1 = 2 marks

Trilobites are thought to be closely related to three other groups of fossil arthropods; helmetids, tegopeltids and naraoids. The tegopeltids and helmetids are the two most closely related groups. These two groups are more closely related to trilobites than they are to naraoids. The diagram below illustrates the evolutionary relationships between these four groups.

- b. Write the names of these four groups in the boxes at the top of the diagram below so that the evolutionary relationships between them are consistent with the information provided.

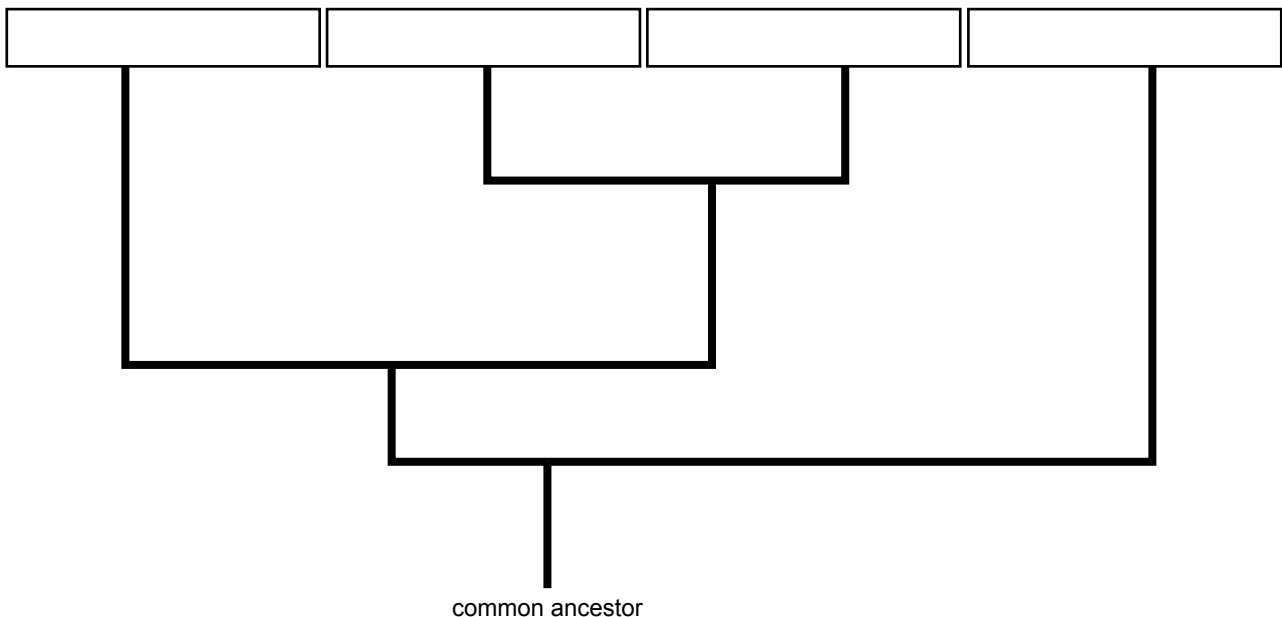

2 marks

c. Suggest one reason why all species of trilobites became extinct.

1 mark

Total 5 marks

Question 8

The following photographs show two fossil hominid skulls.



Figure 7

- a. i. Which of the two skulls (1 or 2) is the more ancient fossil? _____
- ii. List one characteristic of this skull in support of your choice.

1 + 1 = 2 marks

Although extensive searches have occurred, fossils classified in the genus *Australopithecus* and other early hominid genera have been found only in Africa. Assume that these fossils in fact only exist in Africa.

b. What is a possible explanation for these fossils being limited to Africa alone?

1 mark

Total 3 marks